

FICHE PRODUIT

Réf: **BAC-575301 (anciennement BC5753BOX)**

- Bac d'encastrement
- 2 travées
- 5 rangées modulaires
- Platine EDF
- Kit de communication (3 rangées maximum)
- Espace BOX réglementaire



Caractéristiques principales

Dimensions intérieures	Largeur 510 mm
	Hauteur 950 mm
	Profondeur 200 mm /140 mm
Poids	3 kg

Caractéristiques secondaires

Matière	Matière: PVC - M1 ininflammable—épaisseur 4 mm RAL 9010 Température d'utilisation/stockage : -5°C / +40°C
Normes	NFC 15 100 A5 06-2015 NFC 14 100 A1 03-2011 Code de la construction Art R 111-14 PMR

COFRELEC Industrie ZA Horizon, Rue du Président Wilson 44110, CHATEAUBRIANT

Tél : 02 40 81 58 97 Fax : 02 40 28 21 52 www.Cofrelec.com

COTES DU BAC (en mm)

BAC-575301 (BC5753BOX)

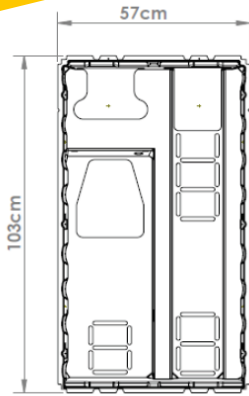

Cotes extérieures

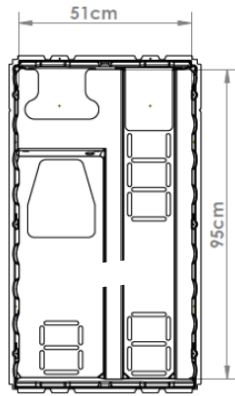

Cotes intérieures

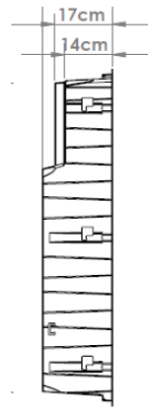

Coupe C- C

Cote A
Bac seul
101 x 55 cm

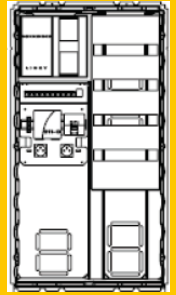

DIMENSIONS DE LA DECOUPE PLACO



Cote A
Accès bas

PMSZ 5763
+ POS 5753
116 cm

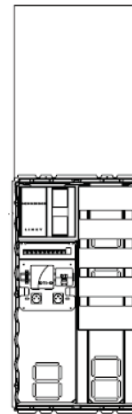

Cote A
Accès haut

KPTS 5753 - 174 cm
KPTA 5753 - 176 cm
PMSZ 5753 + TRAS5706 - 176 cm

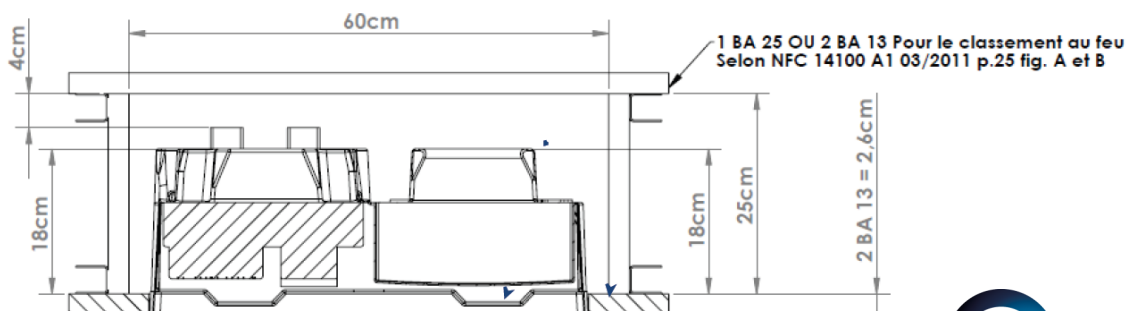
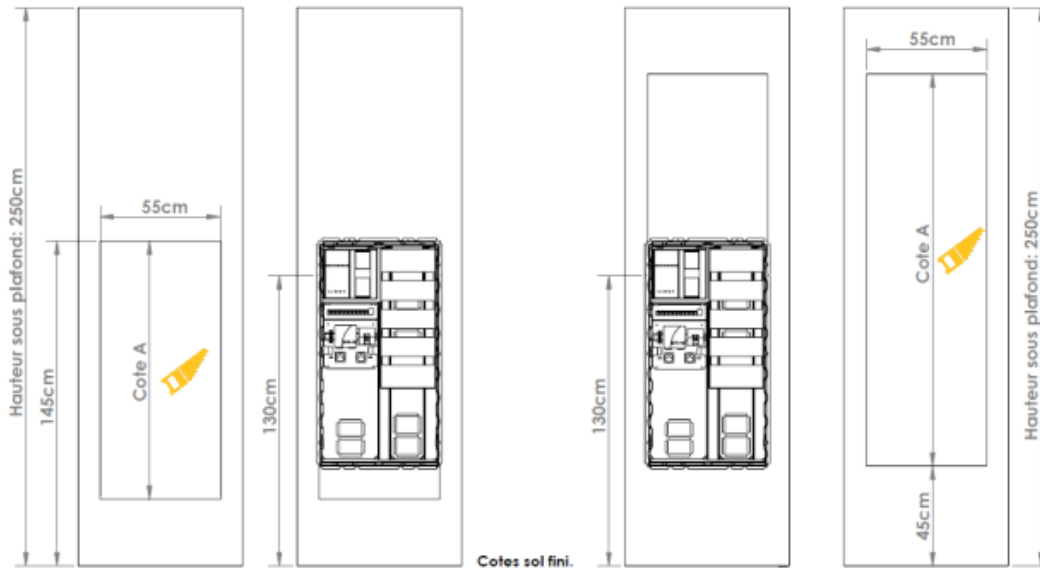

COUPE REGLEMENTAIRE ETEL